

# *N-series*

WALL MOUNTED

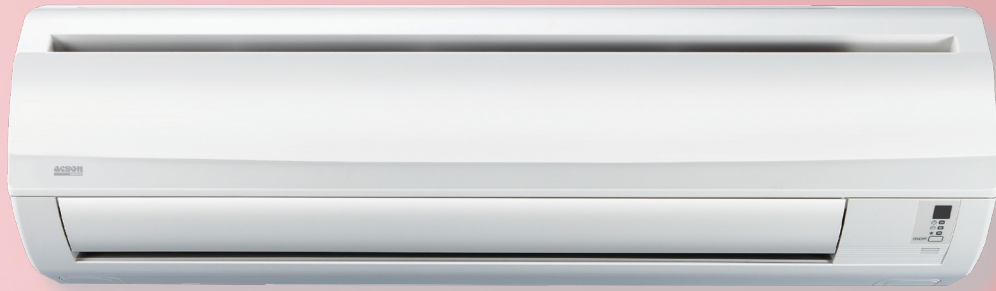

**MyECO**  
R32

**ACSON**<sup>®</sup>  
International  
Air Conditioners

# N-series

## WALL MOUNTED



### R32 NON-INVERTER SERIES

Model: A3WM 30N  
Cooling Capacity: 30,000 Btu/h  
Power Input: 2.91kW



### R32 Refrigerant

Greenery Refrigerant

Acson MyEco Series offers eco-friendly products which lead to a more sustainable future. Products labelled with MyEco are more sustainable and environmental friendly.

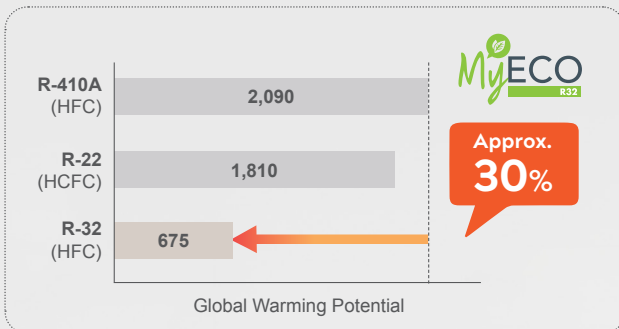

### Why R32?

R32 is a single component refrigerant and used to be one of the components of R410A (binary blend of HFC) which is outstanding for their properties is good in preserve global climate changes.

The R32 refrigerant has zero Ozone Depletion Potential (ODP) and reduction of the global warming potential up to 30% when compared with R410A & R22.

The R32 refrigerant has a low Global Warming Potential (GWP), which one-third lower as compared to R410A



# Filtronz+ Filter

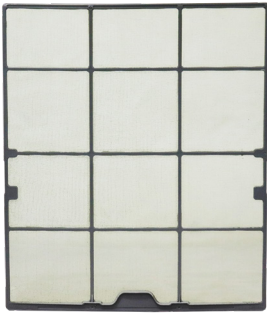

## Filtronz+ Filter

Filtronz+ Filter effectively decompose virus and reduce bacteria & fungus on the air filter surface.

Provide better Indoor Air Quality (IAQ) for healthier life

Non-toxic, non-hazardous & can be recycled

No harm & skin friendly

Easy for cleaning & installation

### Decomposition of Viruses

The effectiveness rate of virus decomposition is increased by 99% in 2 hours

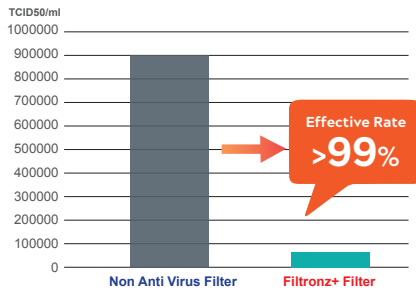

### Reduction of Bacteria

The effectiveness rate of bacteria reduction is more than 99.99% in 24 hours

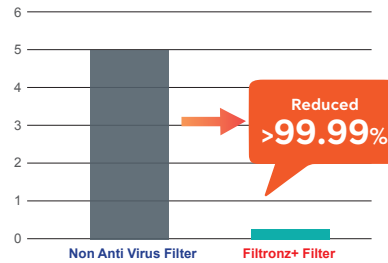

### Reduction of Fungus

Generation of fungus achieved Grade 0 in 24 hours (No fungus visible under the microscope)

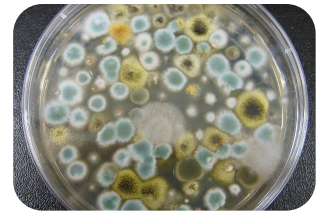

*\*Image is for illustration purposes*

## How Filtronz+ Filter works?

### Step 1

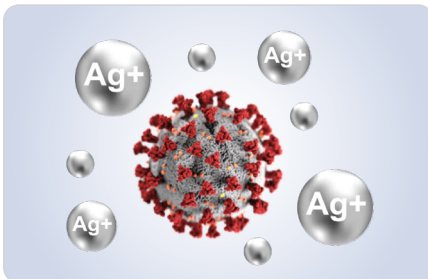

Silver ions (AG+) on the filter absorb virus to the filter surface

### Step 2

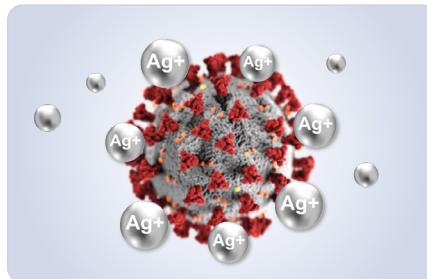

Combination of organic and inorganic components simultaneously react to change the protein that exists on the virus surface

### Step 3

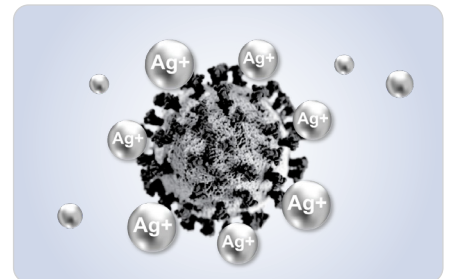

Enzyme protein inactivated, thus the viruses are decomposed and prevented from spread



## Outdoor Unit Design

Whole new grille design for R32 3HP Outdoor Unit allowing better air flow rate and heat exchange efficiency.

# Features | Cooling Comfort

## Advanced Fan Motor Design

Acson having the Silicon Controlled Rectifier (SCR) continuous fan motor which allows for seamless and quiet transitions between fan speeds. Personalise with 5 selectable fan speeds, airflow can be precisely controlled through smoother air throw.

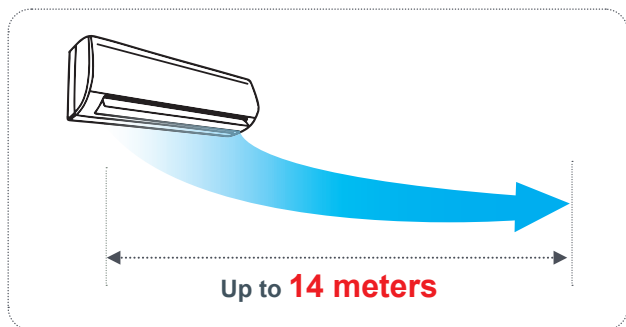

## Long & Wide Air-flow

The cooling air can provide stronger airflow to cover large area of the room. Your satisfaction is further increased when the reach of air is up to 14 meters from the unit to ensure the cool wind in every corner.

## Fast Cooling Turbo Mode

Turbo mode will allow the fan to boost at maximum speed. The extra airflow rapidly provide extra cooling effect. In 20 minutes, your room will cool 33% faster than normal operating especially larger space.

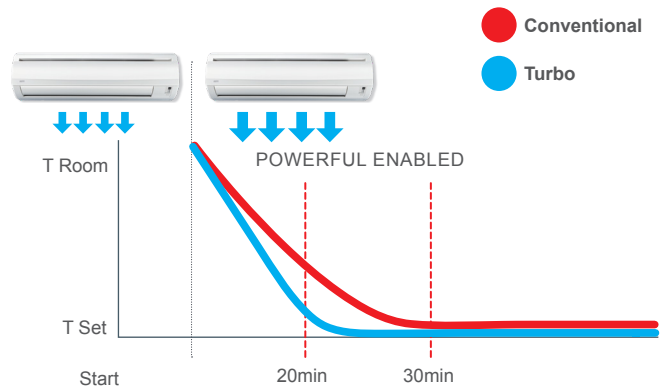

## Cooling Mode

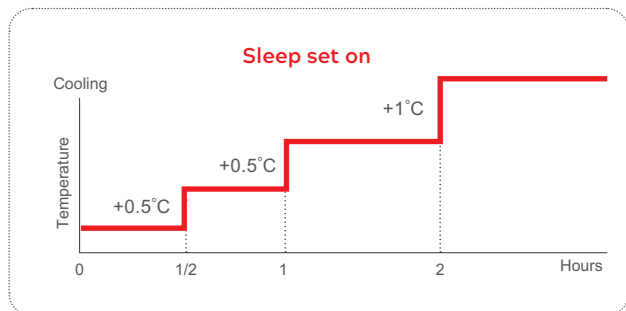

## Sleep Mode

Unwind at the end of the day with Sleep Mode, which gradually increases set temperature according to the regular sleeping temperature patterns for an effortlessly personalised sleeping environment.

# Design Optimization

## Flexible Piping

Designed for your convenience, this series comes with maximum piping lengths up to 50m for high flexibility in system design & installation.

	R410A (A5WM30N)	R32 (A3WM30N)
Max. Piping Length (m)	45	50
Max. Piping Elevation (m)	25	30

Comparison between R410A & R32

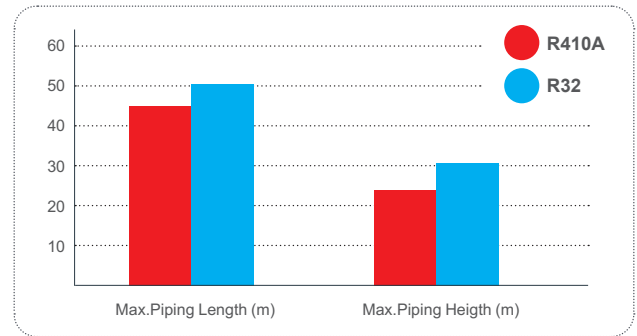

## Improved Quality Satisfaction

Insulation plays important role for air conditioner. In order to improve the quality, extra insulation has been added on the air discharge and overall unit as countermeasure against sweat.

Front Cover

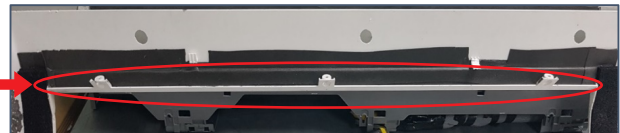
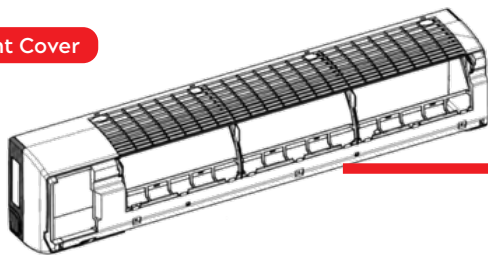

Chasis & Air Discharge

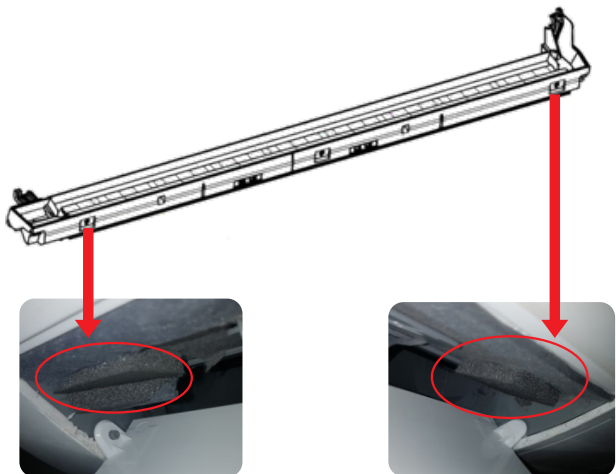
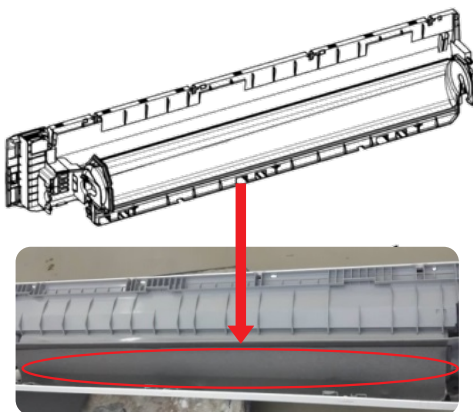

# Excellent Reliability

## MY Acson, MY Control (Optional Accessory)

Specification		
Dimension	H x W x D (mm)	32 x 50 x 15
Wi-Fi Frequency		2.4GHz
Network Configuration		
Out-of-home Control		Internet
In-home Control		LAN, Bluetooth
Electrical Specification		
Communication Protocol		NS
Input Supply	Voltage	5V
	Current	150 mA
	Power Consumption	750 mW
Supported OS		Android 5 or later; IOS 9 or later



### MY Complete Control

- Setting different modes (e.g: cool, dry, fan, turbo, sleep, quiet mode)
- Controlling fan speed, air flow direction & temperature settings
- Controlling the Zoning System

### MY Convenience

- Set 7-day schedules & timers that adjust AC according to your lifestyle
- Control every AC unit from your couch - no need to go racing room-to-room changing settings
- Guest sharing option - possible to be both hospitable and safe

### MY Comfort

- Pre-cool your room whilst still in the workplace or office.
- Room is already pre-cooled according to your desired settings as you reach home.

### MY Energy-Efficient

- Monitor and track energy consumption for better budget planning

\*subject to applicable model

## Peace of Mind Warranty Service

Acson products are designed with durable & reliable quality. Our units are come with 5 years warranty for compressor and 1 year warranty for general parts.



\*1<sup>st</sup> year free labour and compressor.  
\*2<sup>nd</sup> - 5<sup>th</sup> year free compressor only.

## Double Protection

### Automatic Restart

When there is sudden power failure, the unit can restart automatically and recovering the last setting condition once the power supply is back.

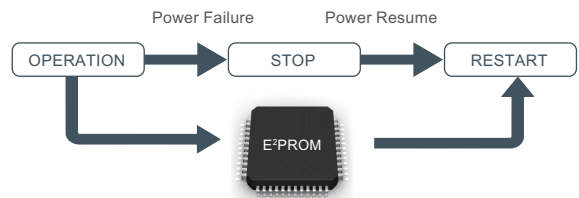

### Self Diagnosis System

Errors can be detected and displayed by blinking LEDs with a series of sensors and intelligent control board to inform user the detected malfunctions.

# Specifications

## Non Inverter N Series (R32)



Model		Indoor		A3WM 30N
		Outdoor		A3LC 30F
Nominal cooling capacity			Btu/h	30000
			kW	8.79
Nominal Total Input Power		W		2900
Nominal Running Current		A		13.10
Power Supply		V/Ph/Hz		220-240 / 1 / 50
Refrigerant Control		Outdoor Capillary Tube		
EER		W/W		3.03
CSPF		Wh/Wh		3.22
Indoor unit	Control	Operation		LCD Remote Controller
		Air Discharge		Automatic Louver (Up & Down)
	Airflow	Turbo	l/s(CFM)	448 (950)
		High	l/s(CFM)	439 (931)
		Medium	l/s(CFM)	359 (760)
		Low	l/s(CFM)	312 (661)
		Quiet	l/s(CFM)	269 (569)
	Sound Pressure Level (T/H/M/L/S)		dB(A)	52/51/46/42/39
	Unit Dimension	Height	mm(in)	310 (12.21)
		Width	mm(in)	1289 (50.75)
		Depth	mm(in)	240 (9.45)
	Packaging Dimension	Height	mm(in)	396 (15.59)
		Width	mm(in)	1382 (54.41)
Depth		mm(in)	316 (12.44)	
Unit Weight		kg(lb)	16 (35.27)	
Airflow		l/s(CFM)	911 (1930)	
Sound Pressure Level		dB(A)	54	
Unit Dimension	Height	mm(in)	695 (27.36)	
	Width	mm(in)	930 (36.61)	
	Depth	mm(in)	350 (13.78)	
Packaging Dimension	Height	mm(in)	760 (29.92)	
	Width	mm(in)	1075 (42.32)	
	Depth	mm(in)	480 (18.90)	
Unit Weight		kg(lb)	53 (116.85)	
Piping Connection	Liquid	mm (in)	9.52 (3/8)	
	Gas	mm (in)	15.90 (5/8)	
Maximum Piping Length		m	50	
Maximum Piping Elevation		m	30	
Refrigerant Type		R32		

CSPF = Cooling Seasonal Performance Factor  
 MEPS = Minimum Energy Performance Standard

- All specifications are subject to change by the manufacturer without prior notice.
- Nominal Cooling Capacity is based in the conditions: Cooling 27°C DB / 19°C WB indoor and 35°C DB / 24°C WB outdoor.
- Sound Pressure Level is according to JIS C 9612 standard. Position of the measurement point is 1m in front and 0.8m below the unit.
- Units are tested & compiled to international standards such as ISO 5151.



A3LC 30F



**ACSON MALAYSIA SALES & SERVICE SDN.BHD.**

*a member of DAIKIN group*

Business Registration NO.198401017130 (129688-D)

No. 7A, Jalan 13/4, Seksyen 13, 46200 Petaling Jaya,  
Selangor Darul Ehsan, MALAYSIA

Tel : +603 7964 8200 Sales Fax : +603 7956 9909

Service Fax : +603 7956 9907 Acson Careline : 1300 22 3344

Penang	: +604-5377 176	Pahang	: +609-5178 696
Perak	: +605-3129 828	Kelantan	: +609-7405 233
Melaka	: +606-2926 196	Sarawak	: +6082-344 128
Johor	: +607-3551 599	Sabah	: +6088-420 205

[www.acson.com.my](http://www.acson.com.my)

Authorized Dealer :

Products manufactured in an ISO certified facility.  
This document contains the most current product information as of this printing.  
For the most up-to-date product information, please logon to [www.acson.com.my](http://www.acson.com.my)